

SPA and SALON LOCKERS

Salsbury Industries offers a complete line of quality lockers designed specifically for spas and salons. Our spa and salon lockers are engineered to withstand high humidity environments and heavy usage in a variety of locker room settings. Constructed of premium quality materials, Salsbury lockers are available in various styles, sizes, colors and configurations to meet your specific needs. These lockers can be ordered by phone or online at www.lockers.com.



People Committed to Quality Since 1936®

SPA and SALON LOCKERS

Designer Wood Series - 12" Wide



DESIGNER WOOD LOCKERS - 12" WIDE

- Constructed of industrial grade particleboard and covered with durable high pressure laminate.
- Ideal for spas and salons, health clubs, locker rooms, country clubs, sports and athletic facilities or wherever a professional environment is desired.
- 1 wide units come fully assembled while 3 wide units require minor assembly.
- All locker doors include heavy duty concealed hinges and a lift up handle and recessed hasp for added security.

CONFIGURATIONS

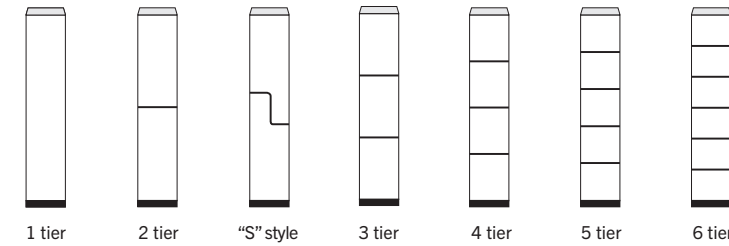

TOP AND SIDE OPTIONS

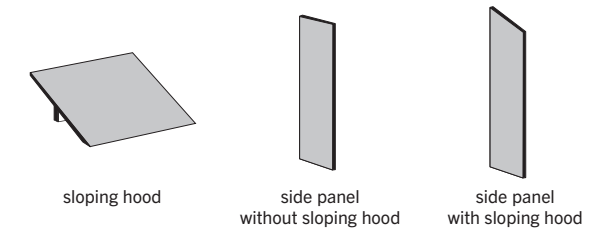

COLOR OPTIONS

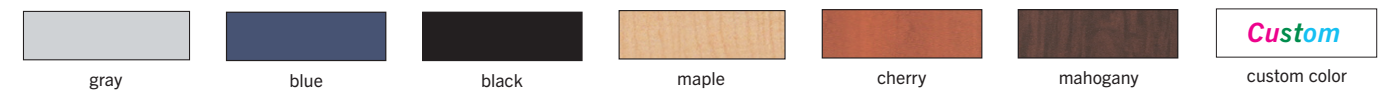

Custom colors - 25% upcharge (minimum fifteen (15) frames) To view all colors visit: www.lockers.com/customdesignerlockers

LOCK OPTIONS / NUMBER PLATES

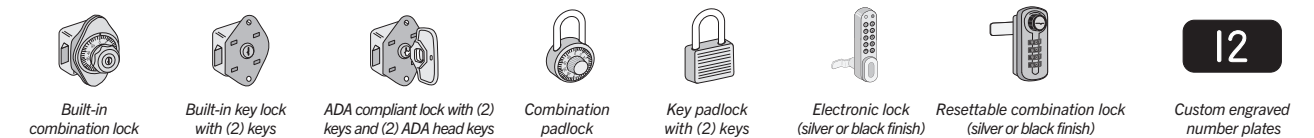

DISPLAYED WITH OPTIONAL SIDE PANEL AND SLOPING HOOD

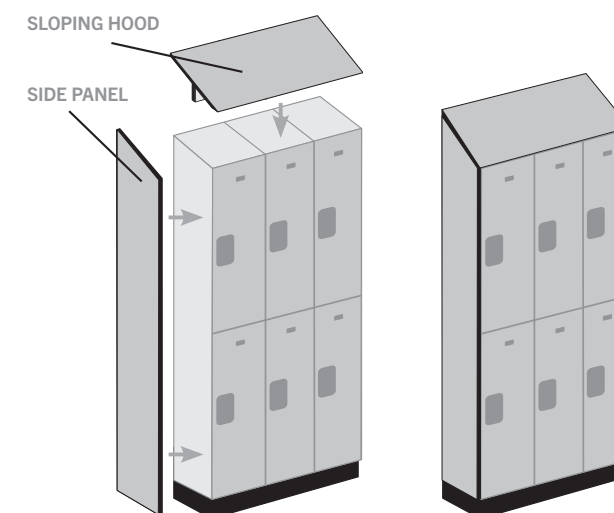

Online Resources

- Product Information
- 3D Revit / BIM Models
- Detailed Specifications
- Technical Drawings
- Augmented Reality (AR) Models
- Installation Instructions
- AutoCAD Drawings



Visit: www.lockers.com/Architectural-Resources

SPA and SALON LOCKERS

Designer Wood Series - 15" Wide



DESIGNER WOOD LOCKERS - 15" WIDE

- Constructed of industrial grade particleboard and covered with durable high pressure laminate.
- Ideal for spas and salons, health clubs, locker rooms, country clubs, sports and athletic facilities or wherever a professional environment is desired.
- 25% wider than 12" wide designer lockers (locker doors are 15" wide x 3/4" deep).
- All locker doors include heavy duty concealed hinges and a lift up handle and recessed hasp for added security.

CONFIGURATIONS

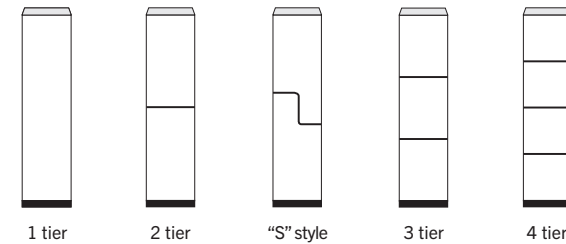

TOP AND SIDE OPTIONS

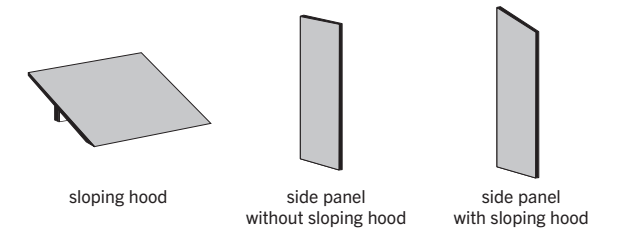

COLOR OPTIONS

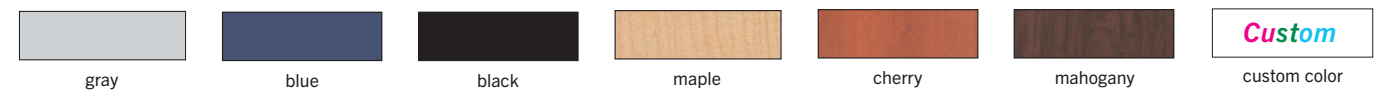

Custom colors - 25% upcharge (minimum fifteen (15) frames) To view all colors visit: www.lockers.com/customdesignerlockers

LOCK OPTIONS / NUMBER PLATES

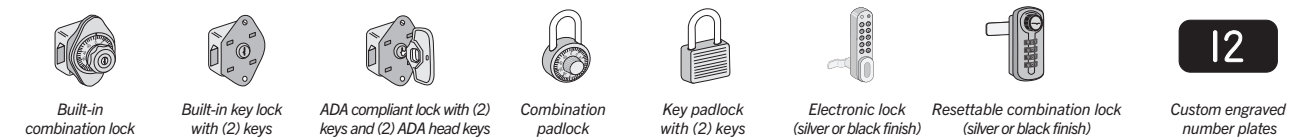

DISPLAYED WITH OPTIONAL SIDE PANEL AND SLOPING HOOD

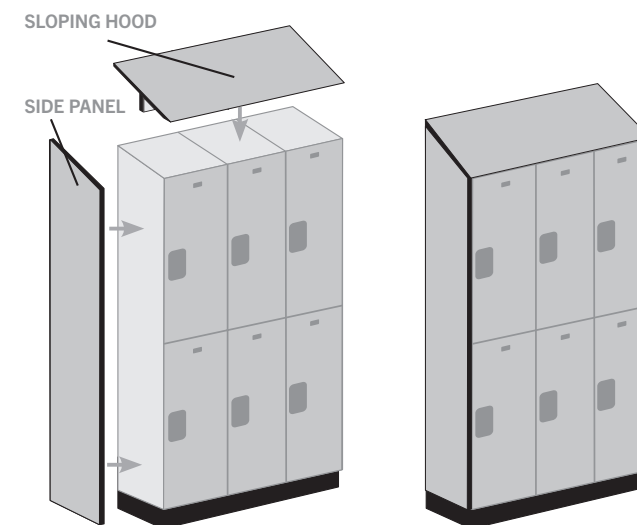

Online Resources

- Product Information
- 3D Revit / BIM Models
- Detailed Specifications
- Technical Drawings
- Augmented Reality (AR) Models
- Installation Instructions
- AutoCAD Drawings



Visit: www.lockers.com/Architectural-Resources

SPA and SALON LOCKERS

Designer Wood Series - 18" Wide



DESIGNER WOOD LOCKERS - 18" WIDE

- Constructed of industrial grade particleboard and covered with durable high pressure laminate.
- Ideal for spas and salons, health clubs, locker rooms, country clubs, sports and athletic facilities or wherever a professional environment is desired.
- 50% wider than 12" wide designer lockers (locker doors are 18" wide x 3/4" deep).
- All locker doors include heavy duty concealed hinges and a lift up handle and recessed hasp for added security.

CONFIGURATIONS

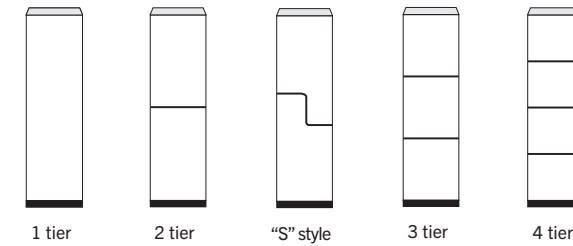

TOP AND SIDE OPTIONS

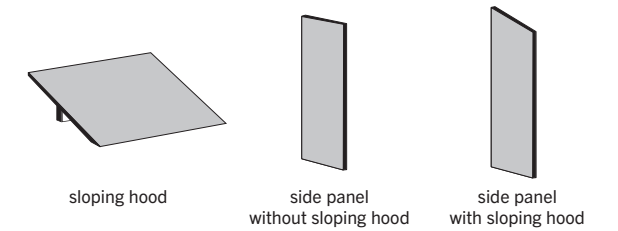

COLOR OPTIONS

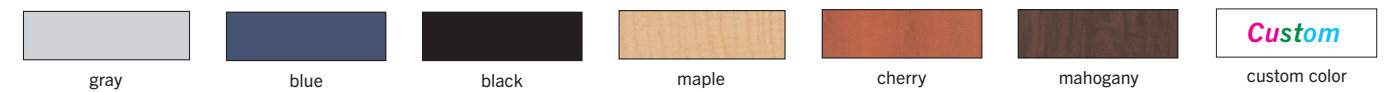

Custom colors - 25% upcharge (minimum fifteen (15) frames) To view all colors visit: www.lockers.com/customdesignerlockers

LOCK OPTIONS / NUMBER PLATES

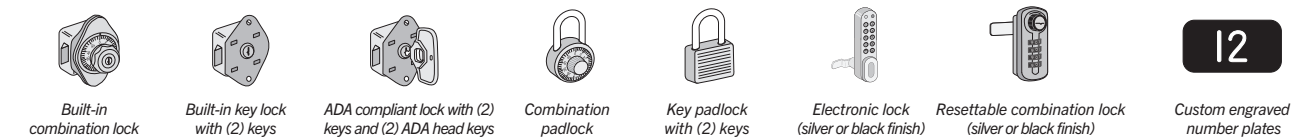

DISPLAYED WITH OPTIONAL SIDE PANEL AND SLOPING HOOD

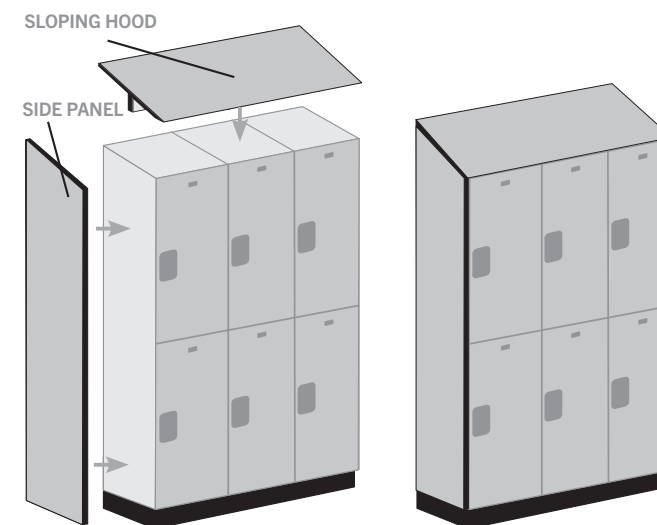

Online Resources

- Product Information
- 3D Revit / BIM Models
- Detailed Specifications
- Technical Drawings
- Augmented Reality (AR) Models
- Installation Instructions
- AutoCAD Drawings

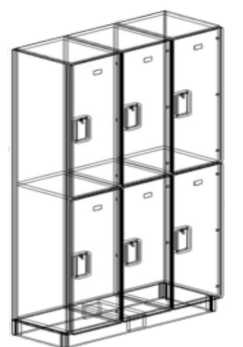

Visit: www.lockers.com/Architectural-Resources

SPA and SALON LOCKERS

Custom Designer Series



CUSTOM DESIGNER LOCKERS

- Constructed of industrial grade particleboard and covered with durable high pressure laminate.
- Ideal for spas and salons, health clubs, locker rooms, country clubs, sports and athletic facilities or wherever a professional environment is desired.
- Custom designer lockers are available in six (6) standard designer colors (gray, blue, black, maple, cherry and mahogany) or a wide variety of custom colors.
- Minimum order of fifteen (15) frames.

CONFIGURATIONS

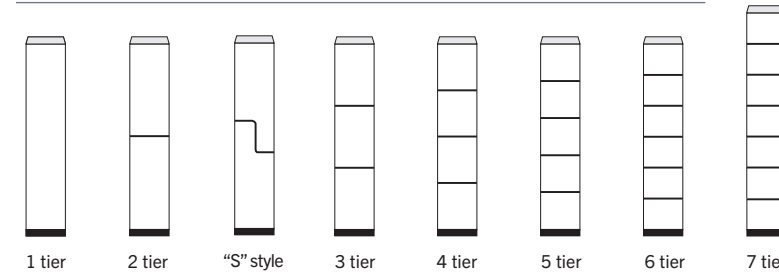

HEIGHT / WIDTH / DEPTH

36"	48"	60"	72"	84"
height				
12"	15"	18"	21"	24"
width				
12"	15"	18"	21"	24"
depth				

COLOR OPTIONS

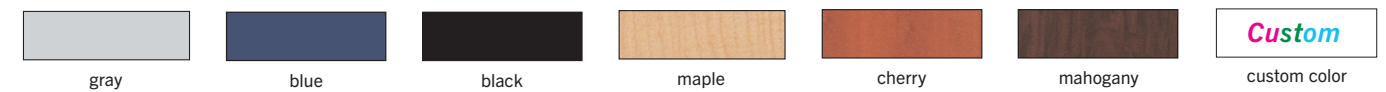

Custom colors - 25% upcharge (minimum fifteen (15) frames) To view all colors visit: www.lockers.com/customdesignerlockers

LOCK OPTIONS / NUMBER PLATES

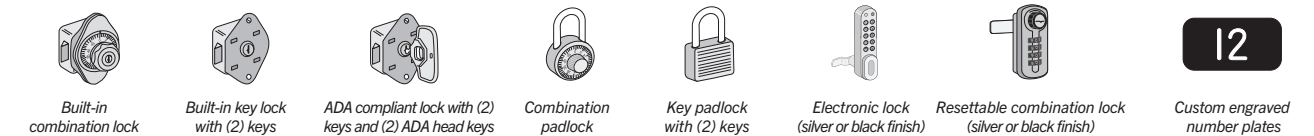

Custom Designer Lockers in 5 Easy Steps

- 1) Specify # of Tiers
- 2) Specify Height, Width and Depth
- 3) Specify Color
- 4) Specify Options
- 5) Submit for Price Quotation

Email: customlockers@lockers.com

Phone: 1.800.562.5377

Fax: 1.800.562.5399

www.lockers.com/customdesignerlockers

Online Resources

- Product Information
- 3D Revit / BIM Models
- Detailed Specifications
- Technical Drawings
- Augmented Reality (AR) Models
- Installation Instructions
- AutoCAD Drawings



Visit: www.lockers.com/Architectural-Resources

SPA and SALON LOCKERS

Plastic Series



PLASTIC LOCKERS

- Constructed of water resistant high grade ABS plastic that combines strength and durability.
- Ideal for spas and salons, pool areas, gyms, restaurants, sports and athletic facilities and other high humidity environments.
- Include stainless steel hinges and a stainless steel hasp to accommodate optional padlocks.
- Available in a gray, tan or blue door finish with a dark gray body and compartment finish providing an attractive two-tone appearance.

CONFIGURATIONS

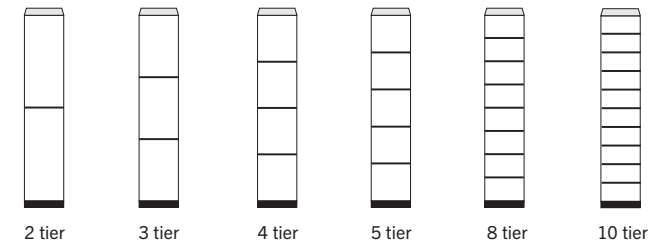

OPTIONS

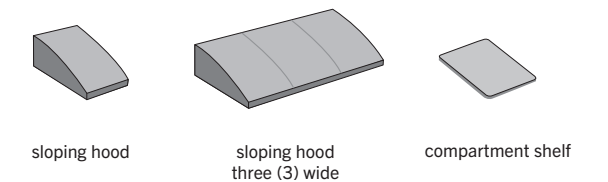

COLOR OPTIONS

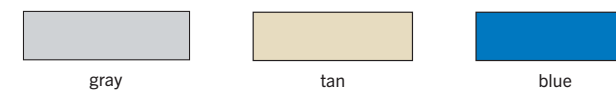

LOCK OPTIONS / NUMBER PLATES



DISPLAYED WITH OPTIONAL SLOPING HOOD

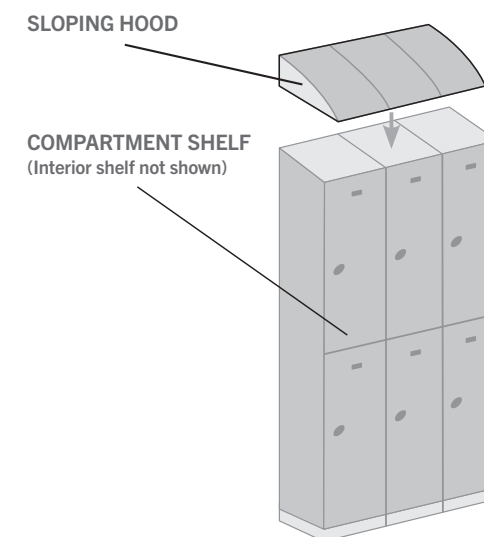

Online Resources

- Product Information
- 3D Revit / BIM Models
- Detailed Specifications
- Technical Drawings
- Augmented Reality (AR) Models
- Installation Instructions
- AutoCAD Drawings

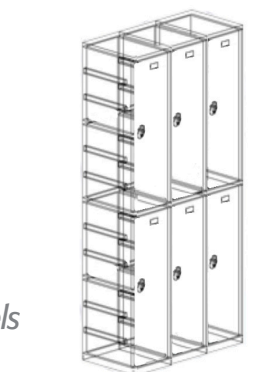

Visit: www.lockers.com/Architectural-Resources

MANUFACTURING SINCE 1936

The Industry Leader in Quality Lockers



ORDER FACTORY DIRECT

Large Inventory and Fast Shipping



SALSBURY INDUSTRIES

Contact us to learn more about
Salsbury Spa and Salon Lockers!

Discounts Available!
Contact Us
for a Quote Today!



People Committed to Quality Since 1936®

Salsbury Industries
18300 Central Avenue
Carson CA 90746-4008

phone: 1.800.562.5377

fax: 1.800.562.5399

phone: 1.323.846.6700

fax: 1.323.846.6800

email: salsbury@lockers.com

website: www.lockers.com

